

## Sink Milanello Workstation

Tank on the right

Kitchen Sinks

Code: 1040 851

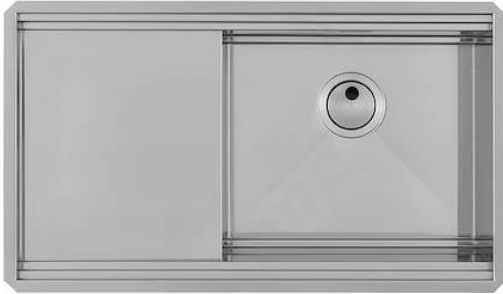

### DETAILS

Edge/Installation Type	Undermount
Finish	Foster brushed
Material	AISI 304 stainless steel
Texture	Brushed in line
Base	90 cm
Dimensions	790x466 mm
Standard fittings	Fixing hooks, gasket, drain, overflow and siphon, boxed packing
Mixer holes	No standard holes
Built-in hole	View technical data sheet

Drainer Yes

---

Width 79 cm

---

Bowl dimension 430x374mm

---

Number of bowls 1 bowl

---

Waste fitting Drain SPACE 3,5"

---

## EQUIPMENT

2 x Black grid Milanello 8100  
602

---

## FEATURES

**Diamond-shape bottom** The draining of water is an important feature in a sink, and it's always taken good care of in Foster products. In the bent-welded sinks, which would have a flat bottom, the proper draining is guaranteed by the elegant beveling, which helps the water flow.

---

**High thickness** 1mm thick steel. A significant thickness, which guarantees the maximum sturdiness and durability.

---

**Perimetral overflow** The overflow is always a security on the Foster sinks that prevents the overflow of water in case of oversights. The perimeter drain solution improves aesthetics thanks to its square and essential shape.

---

**Save space system** Drain and siphon are designed to leave as much space as possible in the under-sink area, more and more useful today for theseparate waste collection systems.

---

**Space waste fitting** The elegant SPACE steel cap closes the drain and leaves no visible residues collected in the basket below. Space also has a small footprint and allows the optimal use of the under-sink compartment.

---

## Triple recess - sliding accessories

The Foster Milano sink has an ingenious design that makes it simple to use a large set of optional accessories. On the topmost supporting step, the innovative Black grids slide, creating a large and practical surface to rinse food and crockery. The second step is meant to support and allow the sliding of a complete combination of accessories, which make some operations practical and safe: rinse, drain, slice, grate... everything can be done inside the sink. The third supporting step is on the bottom of the bowl. On this step one can rest the Black grids, making it possible to rinse foodstuffs without their coming in contact with the bottom of the sink, which may be dirty.

## TECHNICAL DATA

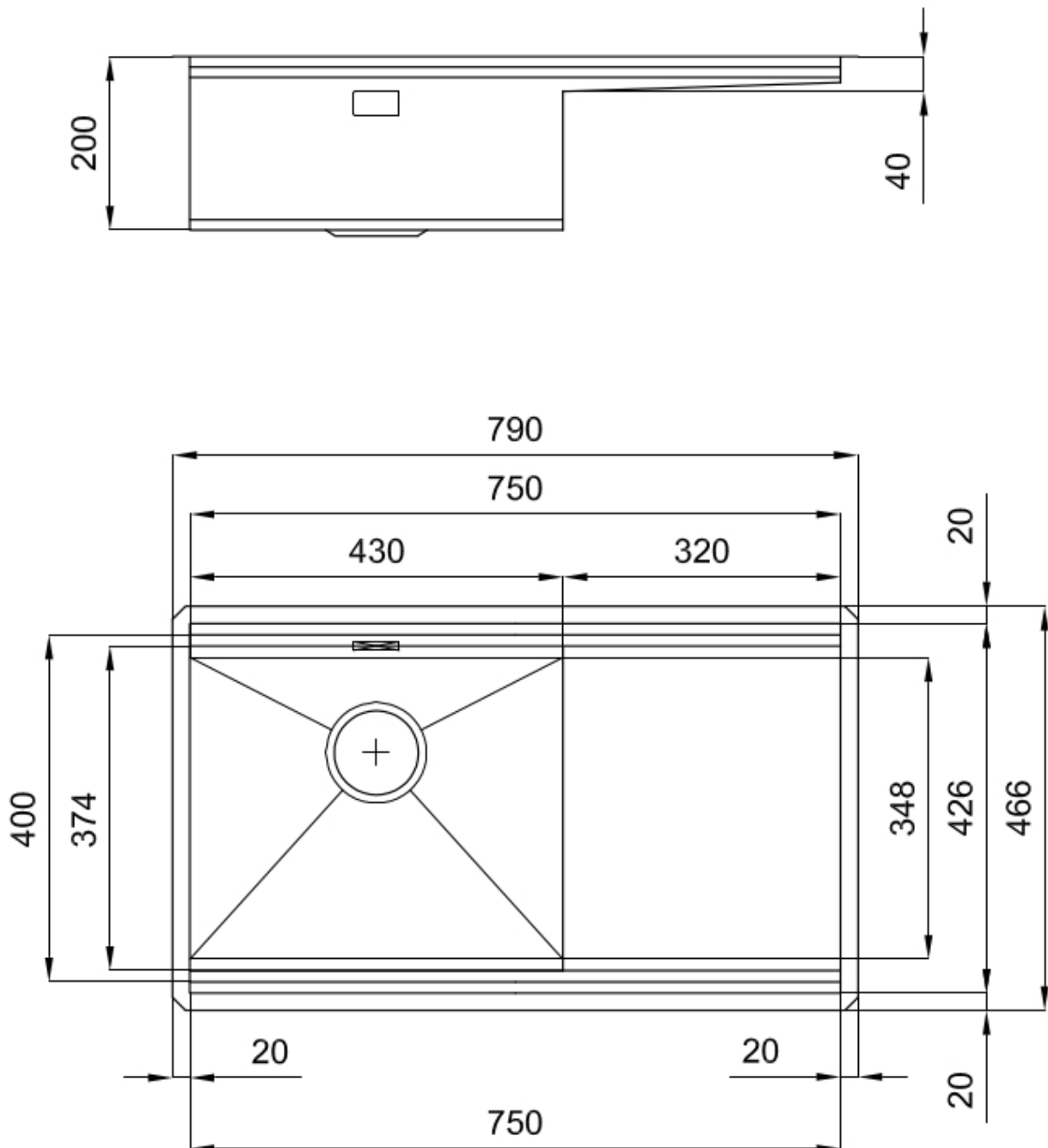

## Milanello Optional accessories / Accessori opzionali

The "rails" system makes it possible to use a combination of numerous accessories. Grids, chopping boards, utensils' ranging system, bowls and containers of different dimensions can be alternated in the workspace with a simple gesture, and can easily be stacked, in order to be on hand at all times.

Il sistema di "corsie" rende possibile l'utilizzo combinato di innumerevoli accessori. Griglie, taglieri, portautensili, vaschette e contenitori di varie dimensioni si alternano nella zona di lavoro con un semplice gesto e possono essere impilati, sempre a portata di mano.



## Milanello Level 1

Compatible accessories/Accessori compatibili:

8100 602  
8631 300  
8642 003  
8644 004  
8644 101  
8657 001

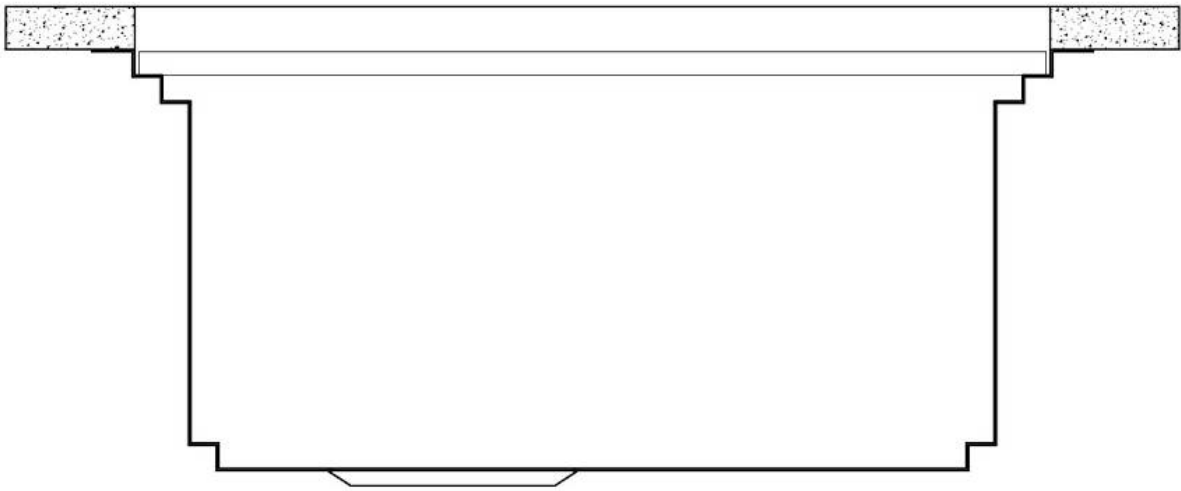

## Milanello Level 2

Compatible accessories/Accessori compatibili:

8100 306

8156 000

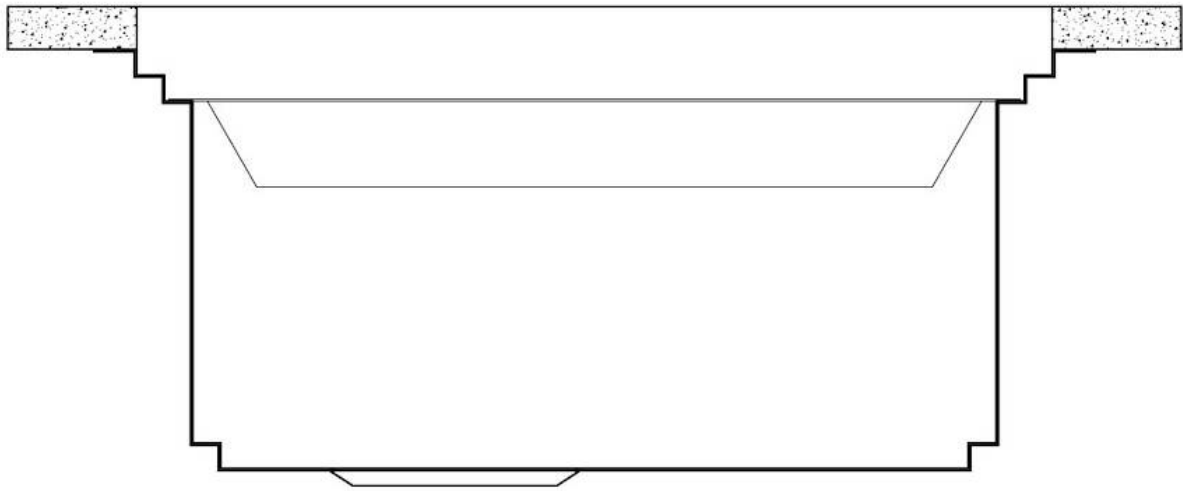

## Milanello Level 3

Compatible accessories/Accessori compatibili:

8100 602

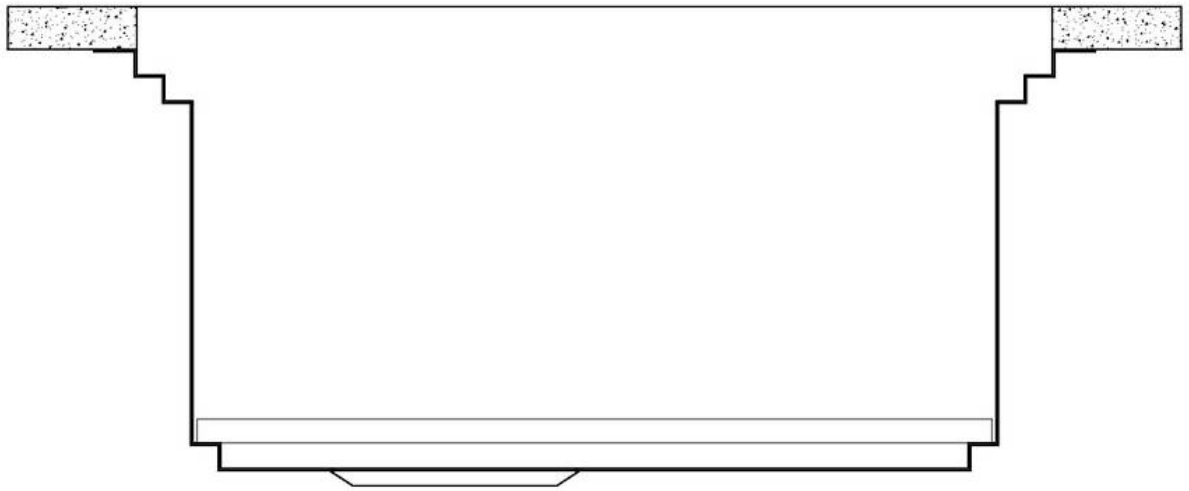

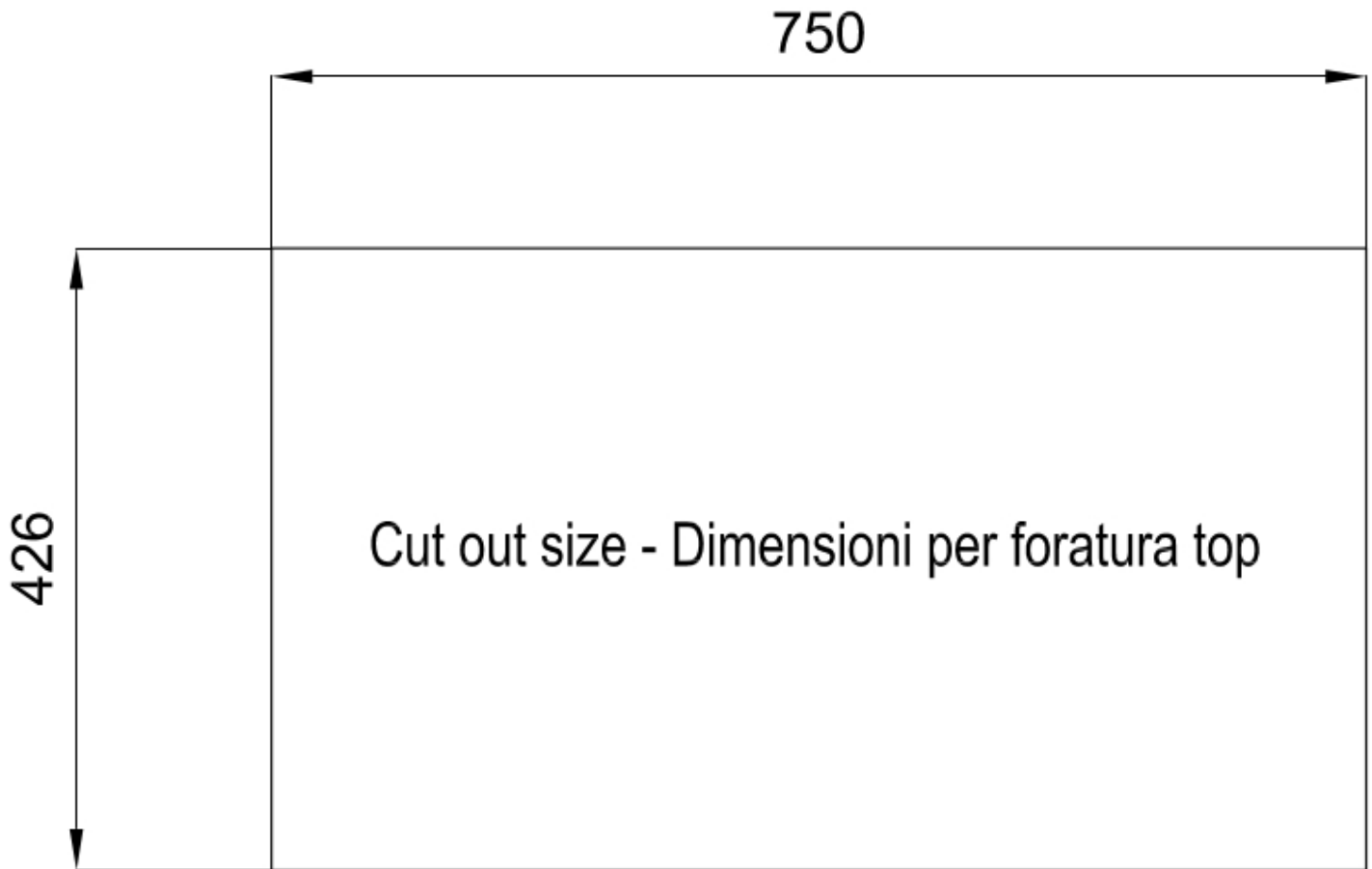



## GALLERY

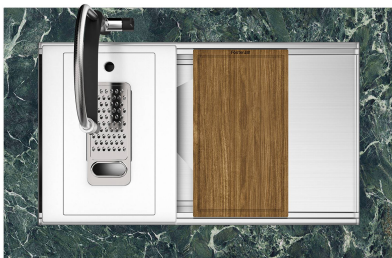
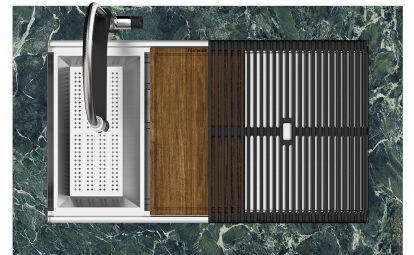
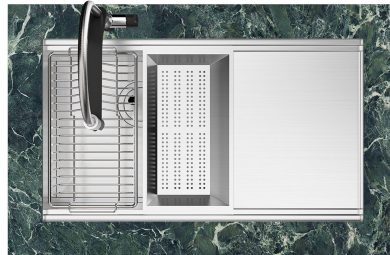
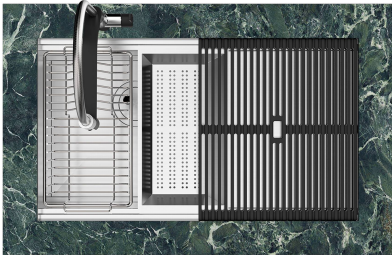
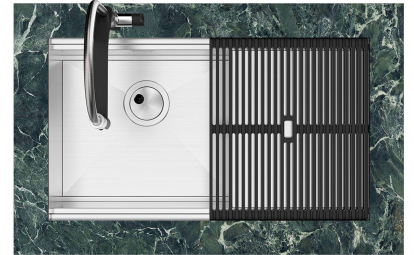

## EQUIPMENT



**Black grid Milanello**

8100 602

## OPTIONAL ACCESSORIES



**HPDE Chopping board**  
8657 001



**HPDE Twin chopping board**  
8644 101



**Stainless steel perforated tray**  
8156 000



**Stainless steel plate rack**  
8100 154

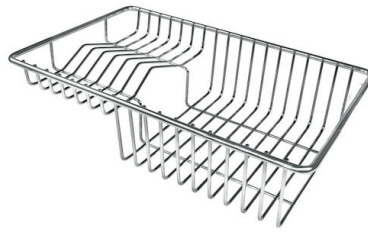

**Stainless steel plate rack**  
8100 303  
\* only in combination with the accessory  
8644 101

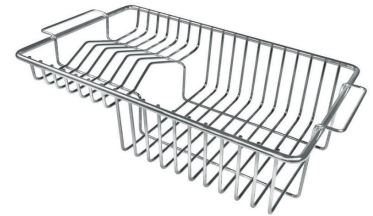

**Stainless steel Plate rack**  
8100 306



**Glass chopping board**  
8631 300



**Graters kit with ring-holder and  
food collection tray**  
8159 101  
\* only in combination with the accessory  
8644 101



**Stainless steel perforated tray**  
8151 000  
\* only in combination with the accessory  
8644 101



**Walnut-wood chopping board**  
8642 004

## RECOMMENDED PAIRINGS

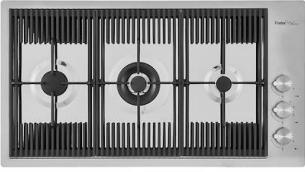

**Cooker hob Milanello**  
7680 000



**Mixer Tap Milanello**  
8425 100